



Hybrid motor starters and motor managers

Reliable motor switching and monitoring

Electronic switching devices and motor control

Electric motors are used in a variety of industrial applications for controlling movements. Motors are often started using classic, mechanical contactor circuits. These often require a great deal of space as well as a lot of wiring effort. The service life of the devices is also limited.

“For a simple, cost-effective solution for future-proof systems, I need modern motor control that is robust, reliable, and durable.”



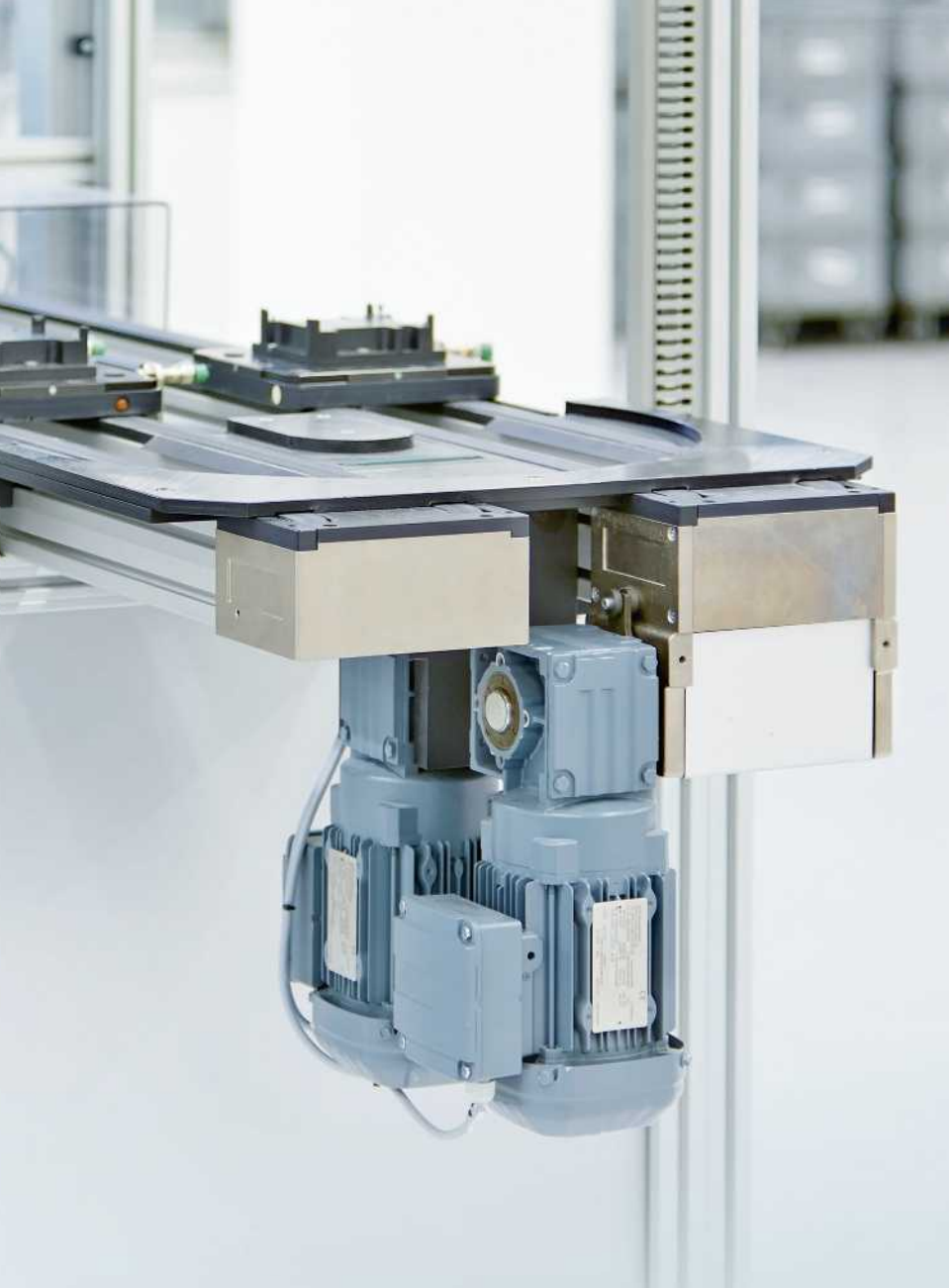

Contents

The CONTACTRON- product range at a glance	4
--	---

CONTACTRON hybrid motor starter technology	6
---	---

CONTACTRON hybrid motor starters: clever switching and safe protection	8
---	---

Network-capable hybrid motor starters	10
--	----

CONTACTRON motor manager: motor and system protection	12
--	----

Solid-state contactors: wear-free switching of single- or three-phase loads	14
--	----

CONTACTRON order overview with accessories	16
---	----

PHOENIX CONTACT Products and solutions for your success	22
--	----

Find out more with the web code

You can find web codes in this brochure: a hash symbol followed by a four-digit number combination.

 **Web code:** #1234 (example)

This allows you to access information on our website quickly.

It could not be easier:

1. Go to the Phoenix Contact website
2. Enter # and the number combination in the search field
3. Get more information and product versions

Or use the direct link:
phoenixcontact.net/webcode/#1234

The CONTACTRON product range at a glance

The CONTACTRON hybrid motor starters combine up to four functions in one device: motor starter, reversing function, motor protection against overload, and emergency stop. In addition to standard devices for parallel wiring, network-capable versions are also available that can be integrated into fieldbus environments. For protection of the entire system, the product range now includes the electronic motor manager (EMM).

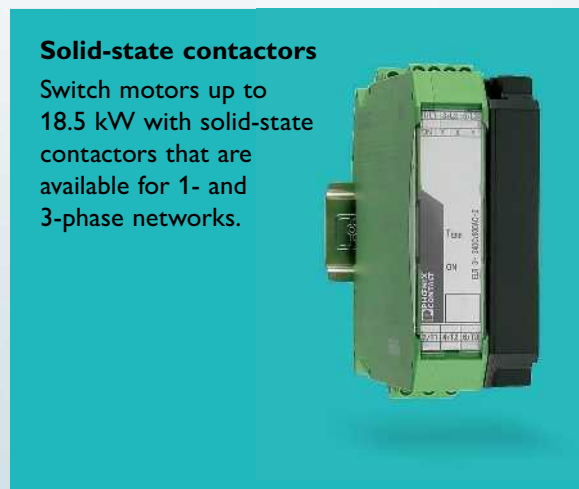

Gateway for integration in the fieldbus environment

A gateway enables up to 32 devices to be networked in a fieldbus environment. In addition to protocol conversion and the coordination of devices, it serves as a data interface to the higher-level controller.



CONTACTRON hybrid motor starter

Switch and reverse motors quickly and reliably with CONTACTRON compact hybrid motor starters.



Can also be networked for integration into a fieldbus environment via a gateway, if preferred.



CONTACTRON motor manager

Detect all critical load states using the motor manager, thereby providing optimum protection for the motor and system mechanics.

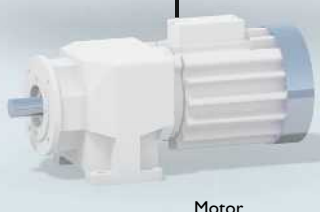
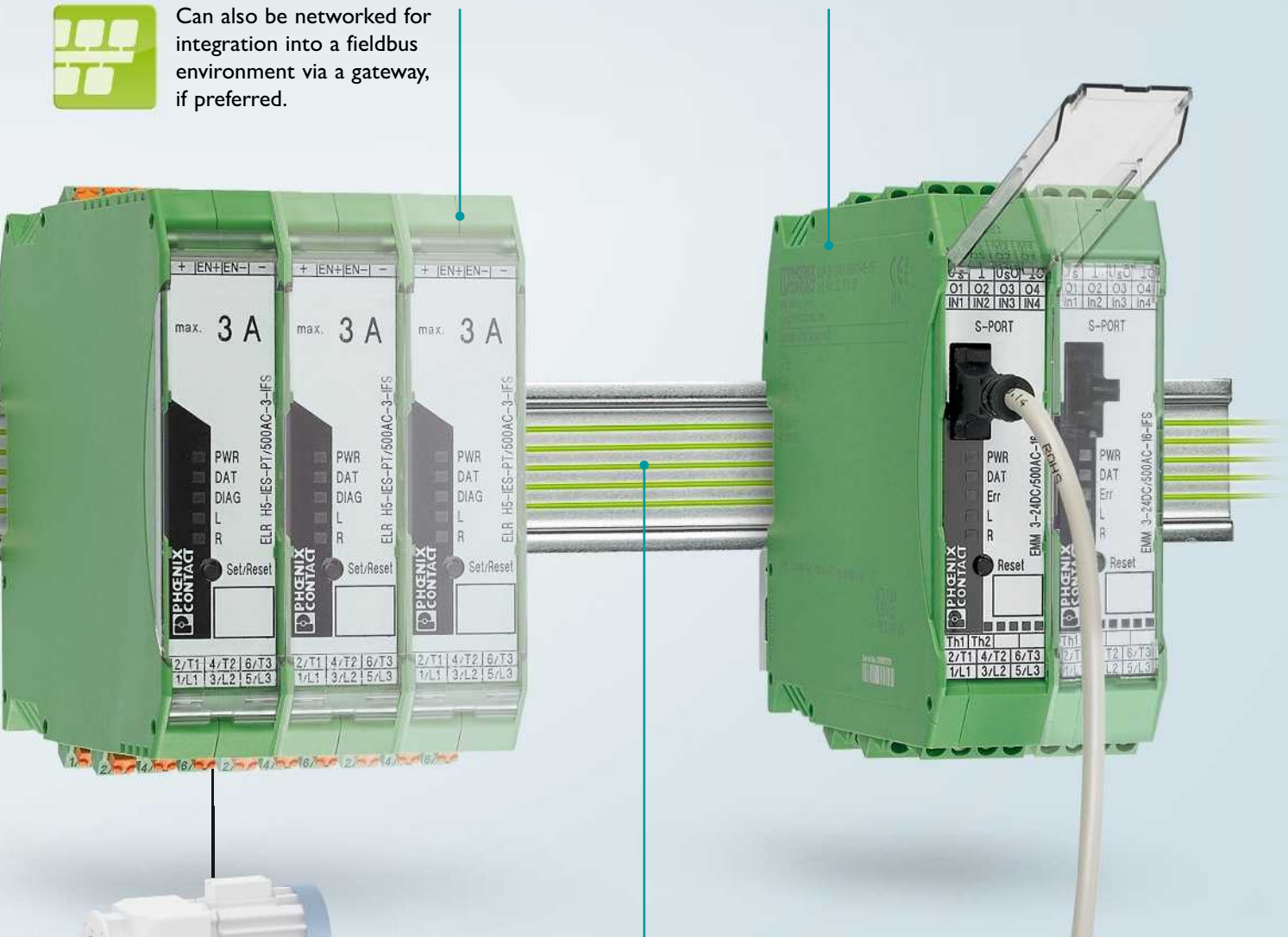

Motor

INTERFACE system (IFS)

The INTERFACE system consists of devices which can be connected to each other via the DIN rail connector (T-BUS). As the usual parallel wiring is redundant, the wiring effort is reduced.

CONTACTRON

hybrid motor starter technology

CONTACTRON hybrid motor starter technology is a microprocessor-controlled combination of wear-free solid-state technology and robust relay technology. The semiconductors execute the wear-prone on and off switching procedures, while the relays only conduct low-loss current. This enables soft switching and considerably reduces the load on the relay contacts.

CONTACTRON
HYBRID
TECHNOLOGY

i Web code: #1077

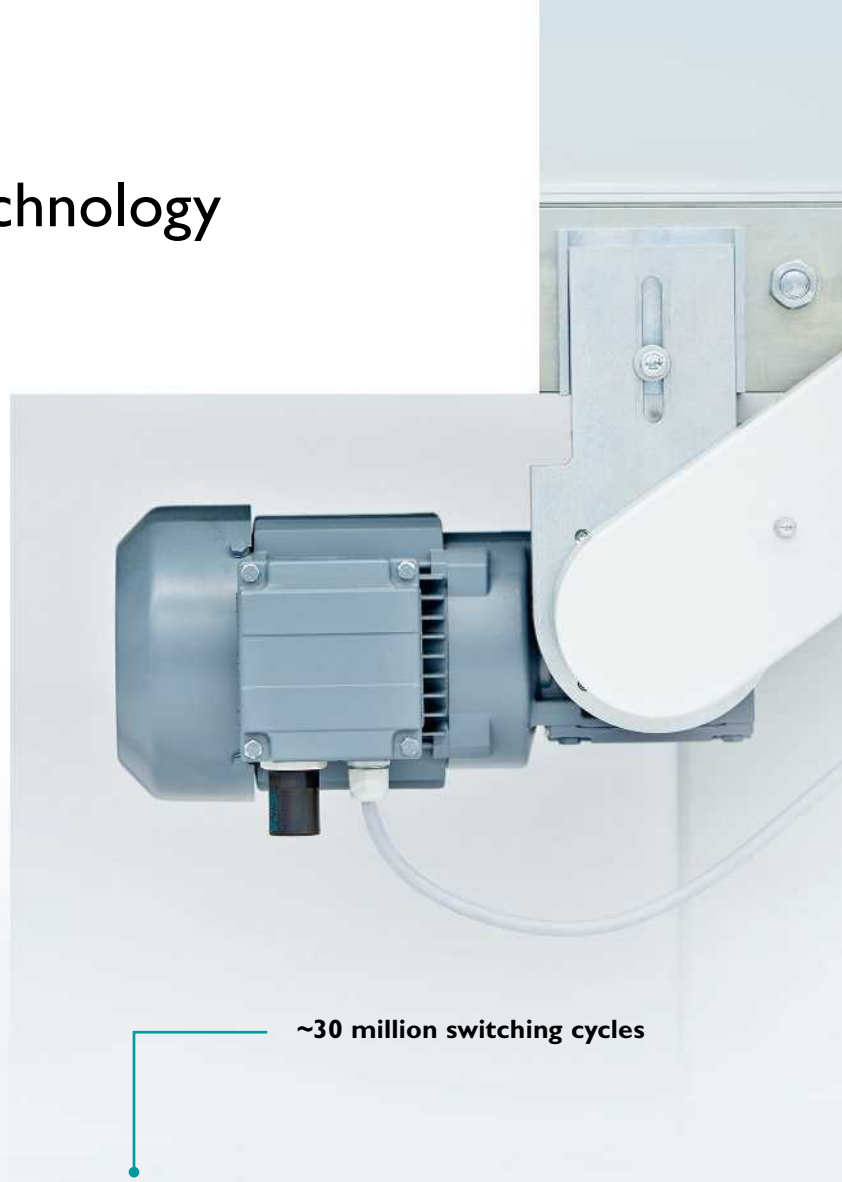

~30 million switching cycles

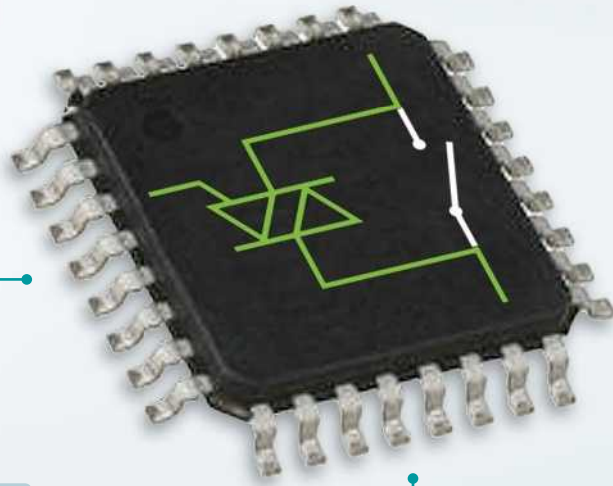

10 times longer service life

Contactor:



Hybrid motor starter:



Reduce the amount of space and wiring effort required by ~75%

CONTACTRON hybrid motor starter vs. conventional reversing contactor

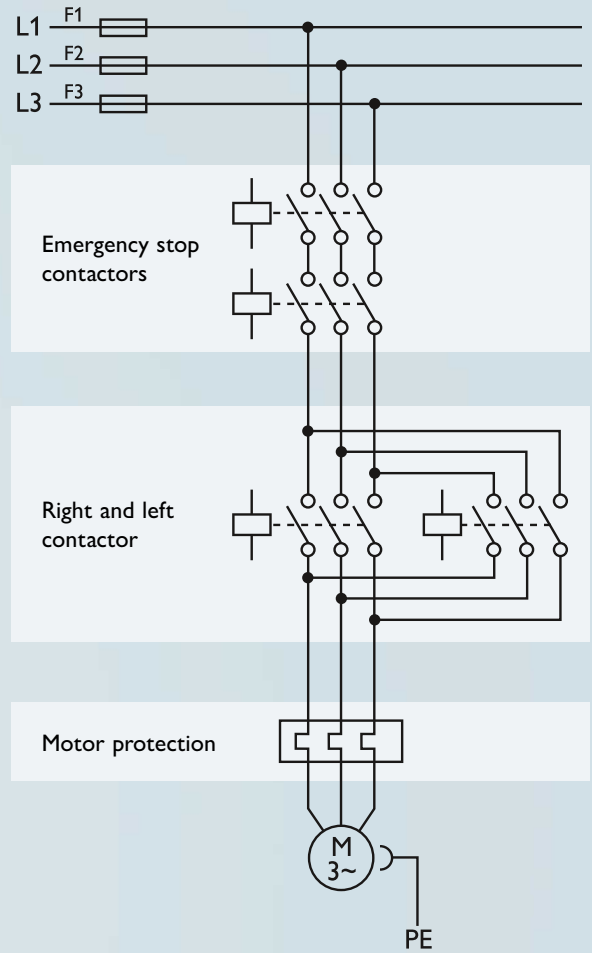

CONTACTRON compared to traditional solutions:

- CONTACTRON integrates the functions of a conventional reversing contactor, including safety function, into a single device
- Internal load and locking circuits enable clear wiring
- The locking circuit is certified according to UL 508a and UL 60947-1

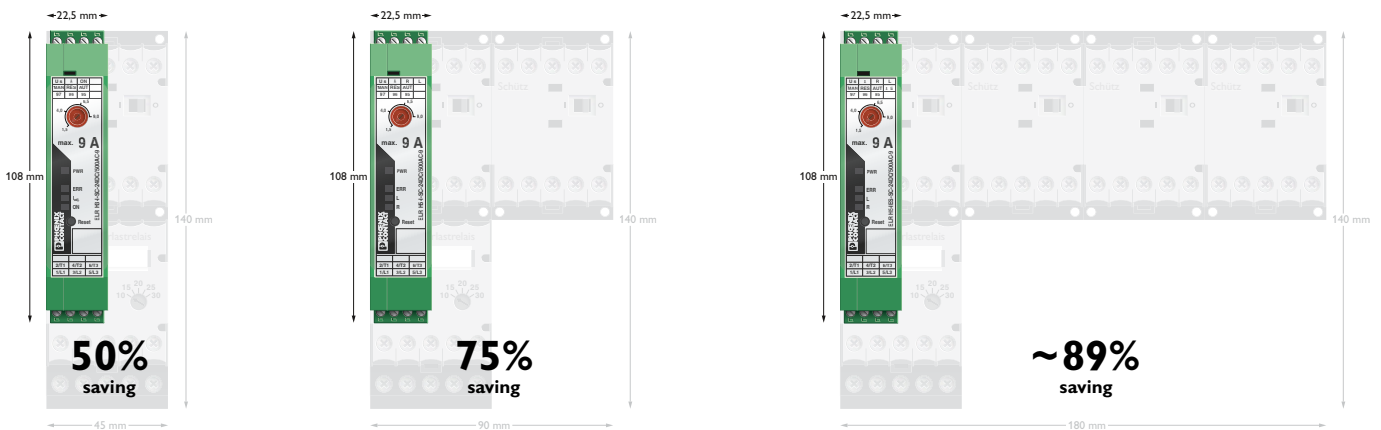

Less space required

Using the CONTACTRON hybrid motor starter, device combinations that would previously take up a lot of space in the control cabinet can now be replaced with one single device.

CONTACTRON hybrid motor starters: Clever switching and protection

Switch motors safely and reliably with CONTACTRON compact hybrid motor starters.

The devices can be used wherever three-phase asynchronous motors, from 50 W to 3 kW, need to be reversed and protected. The product range of hybrid motor starters consists of direct and reversing starters, which are available with various functions such as emergency stop and motor protection.

Short-circuit protection included

With the integrated fuses, the motor starters meet coordination type 2 according to IEC/EN 60947-4-2. These devices can be mounted flexibly on standard DIN rails or on 60 mm busbars.



Cost-efficiency, thanks to needs-based function selection



Forward running

Easy control directly via 24 V PLC output cards or 230 V AC signal.



Reverse running

Optional: reversing function including locking circuit and load wiring.



Motor protection

User-friendly protection by means of the electronic motor protection relay with automatic and remote reset function.



Emergency stop

The integrated safety function enables use in safety-related emergency stop applications.

SIL3
IEC 61508

PL e
ISO 13849-1

Cat.3
EN 954-1



SIL3
IEC 61508

PL e
ISO 13849-1

Cat.3
EN 954-1

Clever switching

CONTACTRON combines all the functions of a conventional reversing contactor in a single device.

Your advantages:

- Less space required, thanks to the slim design: 22.5 mm design width
- Easy wiring, thanks to integrated locking circuit and load wiring
- Service life is up to ten times longer, thanks to gentle switching with CONTACTRON hybrid motor starter technology
- Adjustable motor protection with bimetal function up to 9 A
- Safe shutdown, thanks to integrated safety function up to SIL 3 and PL e

CONTACTRON
HYBRID
TECHNOLOGY

Network-capable hybrid motor starters

Integration into fieldbus systems is implemented using the INTERFACE system connection or the SmartWire-DT™ wiring system. Corresponding gateways are available for all common fieldbus systems.



With bus connection

Connection of hybrid motor starters in a bus system via IFS gateway or SmartWire-DT™.

Gateway

Up to 32 IFS devices can be easily integrated into conventional fieldbus systems and save bus addresses for field devices (gateway parameterization by means of IFS-Conf software).

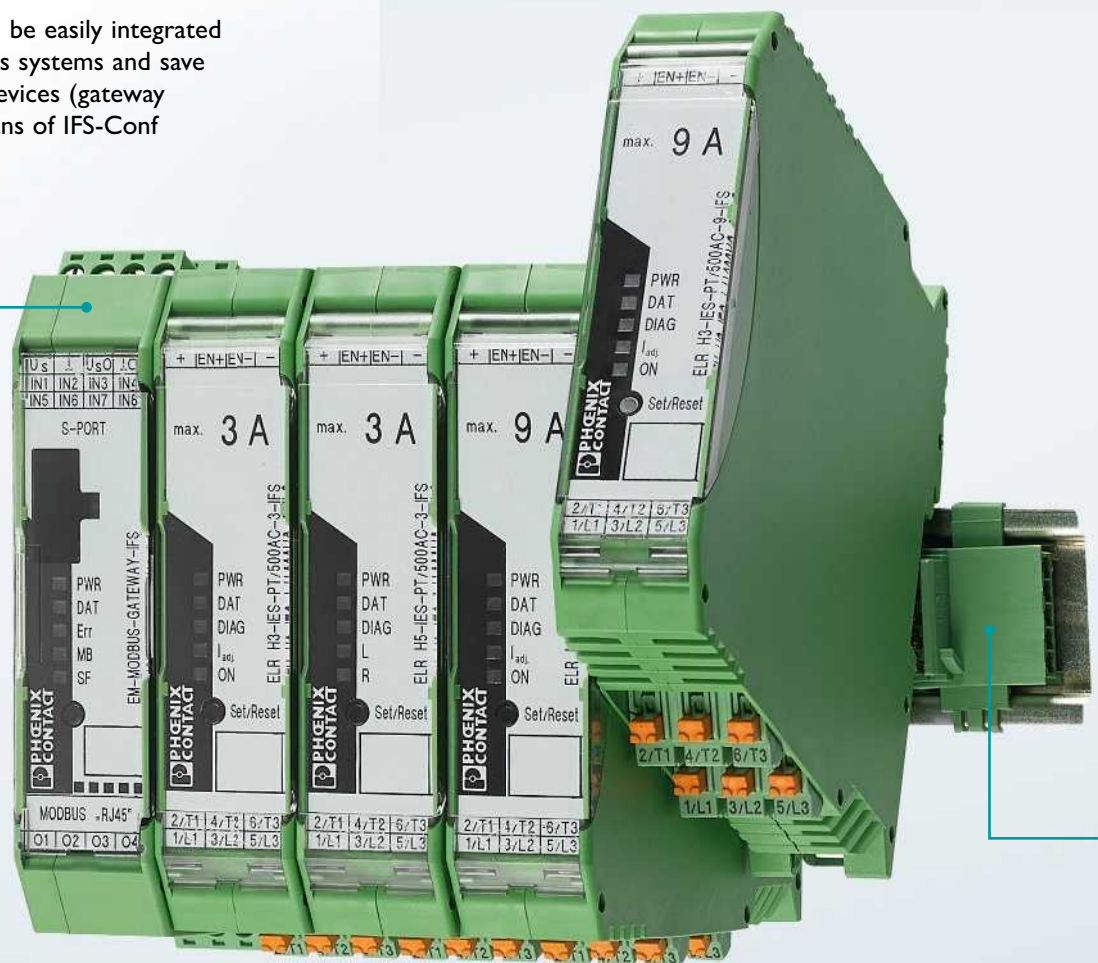

Fieldbus connection via INTERFACE system (IFS)

The hybrid motor starters are connected to PROFINET via the EM-PNET-GATEWAY-IFS. Connection is via a DIN rail connector, which provides the 24 V supply voltage and is also used to control the devices. Digital outputs are not required to control the motor starters. The motors can be safely shut down via enable inputs using a safety relay or safe controller according to PL e. The EM-PNET-GATEWAY-IFS has eight digital inputs and four freely programmable outputs. Particularly in the case of a modular or distributed structure, there is no need for I/O cards at the controller or even remote I/Os. In this case, the position switch is connected directly to the PROFINET gateway.

i Web code: #1078

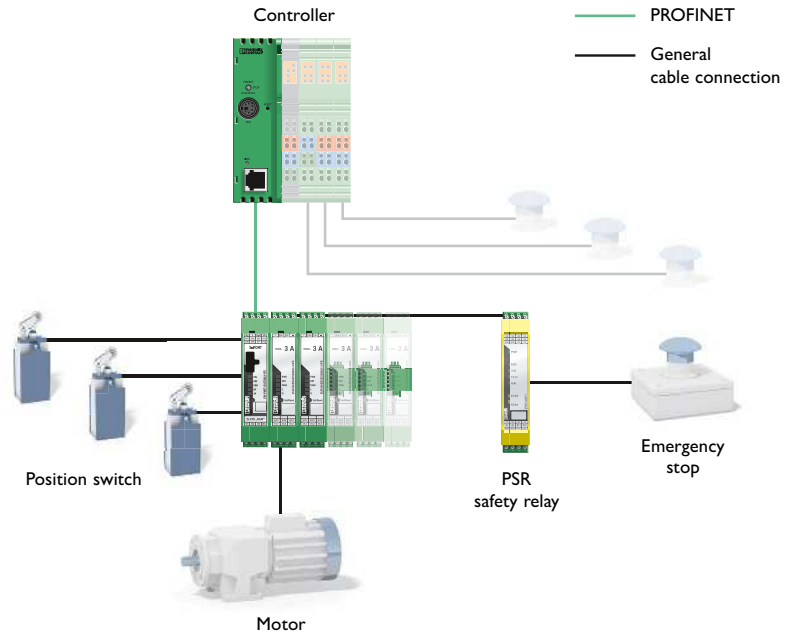

Fieldbus connection via SmartWire-DT™

The hybrid motor starters, as well as the command and signaling devices, are directly connected to the controller via a gateway using SmartWire-DT™. SmartWire-DT™ reduces the wiring effort. You benefit from clearly arranged and compact control cabinets. Safe shutdown is implemented with a PSR safety relay.

i Web code: #1079

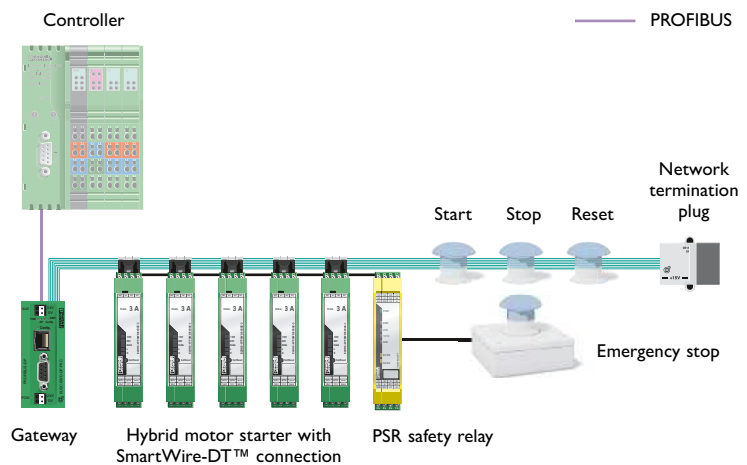

DIN rail connector (T-BUS)

The easy-to-assemble solution for networking, communication, data transmission, and 24 V power supply.

Your advantages:

- Flexible and straightforward fieldbus connection with an appropriate gateway
- Easy 24 V power supply of IFS devices without additional wiring effort
- Fast connection of other IFS devices, thanks to the DIN rail connector latching concept
- I/O cards no longer required (controller), thanks to the 8 digital inputs and 4 digital outputs on the gateway

CONTACTRON motor manager: Motor and system protection

With the motor manager, you can detect all the critical load states throughout the system and benefit from the advantages of modern real power monitoring. If required, the motor manager switches the drive off and thereby protects the motor and system.



Your advantages:

- Integrated full motor protection
- Protects high-grade system parts
- High system availability
- Saves the cost of sensors
- Easy configuration and diagnostics
- ATEX-certified for Ex e motors
- Connection to controller via bus gateway
- Parameterization via FDT/DTM concept with IFS-Conf software*
- Process data such as performance values, operating hours, and switching cycles are safely transmitted between field and control level

* Download free-of-charge from our website.

Reliable monitoring – exact and fast control

Motor managers from Phoenix Contact monitor motors for overload and underload, function, dirt, and wear.

You can therefore provide permanent protection for pumps, actuating drives, fans, and machine tools, for example.

The monitoring is implemented by freely parameterized switching and signaling thresholds. Identical or separate settings can be made for the thresholds relating to the two directions of rotation.

Parameterization relies on the real power consumed (calculated from three currents, voltages, and the phase angle), thereby offering a much more precise

basis than if only the current is taken into consideration, as it is independent of voltage fluctuations and drive load.

System protection requires real power measurement

While a $\cos \varphi$ monitor only detects underload states, and a motor protection relay only detects overload states, real power measurement detects all critical load states of the motor.

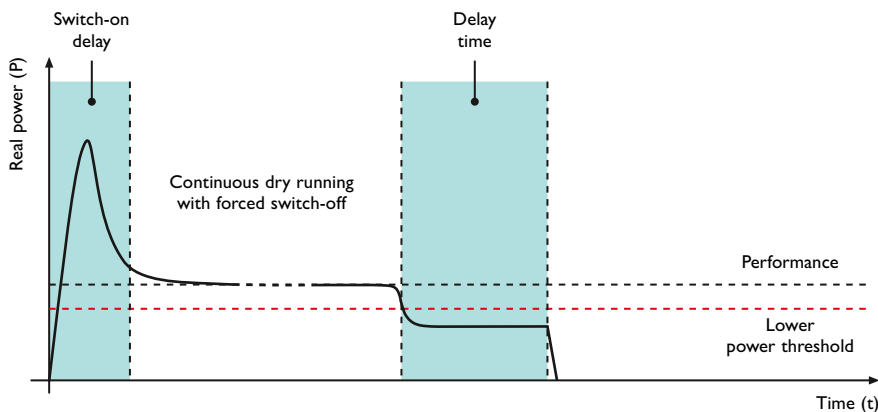
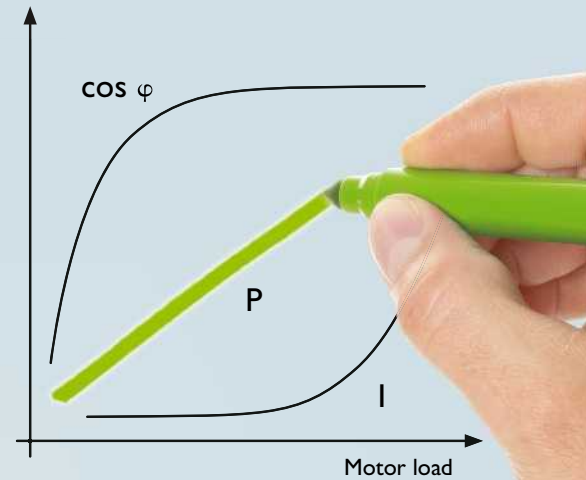

Underload detection in a pump

In the case of motor-driven pumps, the lower power threshold provides reliable protection against hazardous dry running.

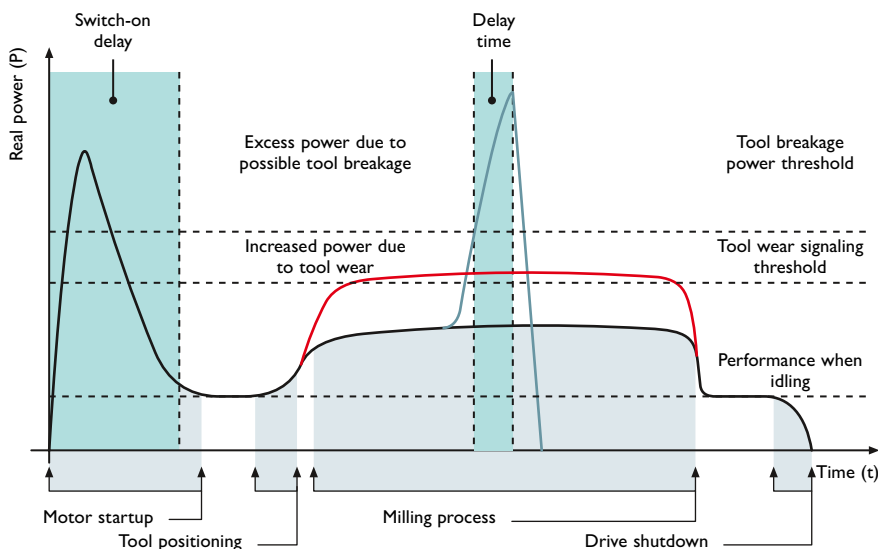

Overload detection in a machine tool

Machine tools are monitored and protected in a similar way. If the feed value on a milling machine is set too high, a tool may break in the "worst case" scenario. The power threshold, parameterized accordingly, can be used to resolve this issue. A signaling threshold also signals tool wear in advance.

Solid-state contactors: Wear-free switching of single- or three-phase loads

Solid-state contactors are far superior to mechanical contactors in terms of switching speed, service life, and robustness. This is because they also work reliably and with stable switching times in dusty or chemically aggressive atmospheres. They switch ohmic and inductive loads silently and without wear. The solid-state contactors from the CONTACTRON series are available for 1- and 3-phase networks and, depending on the type, also provide a reversing function.



Forward running and reverse running

Easy control via a 24 V DC or 230 V AC signal. Locking circuit and load wiring are already included.

Your advantages:

- Reliable and fast switching, thanks to wear-free electronics
- Robust – resistant to shocks and vibrations
- Easy wiring, thanks to integrated locking circuit and load wiring
- Switching capacity up to 18.5 kW
- Direct start and reversing of three-phase asynchronous motors



1-phase solid-state contactors

Wear-free starting of 1-phase AC loads up to 660 V AC/50 A

Applications:

- Production machines and heating systems
- Lighting systems
- 1-phase motors



3-phase solid-state contactors

Wear-free starting of 3-phase AC motors 575 V AC/3 x 37 A

Applications:

- Conveying systems and machine tools
- Pumps and fans
- Mixers and much more

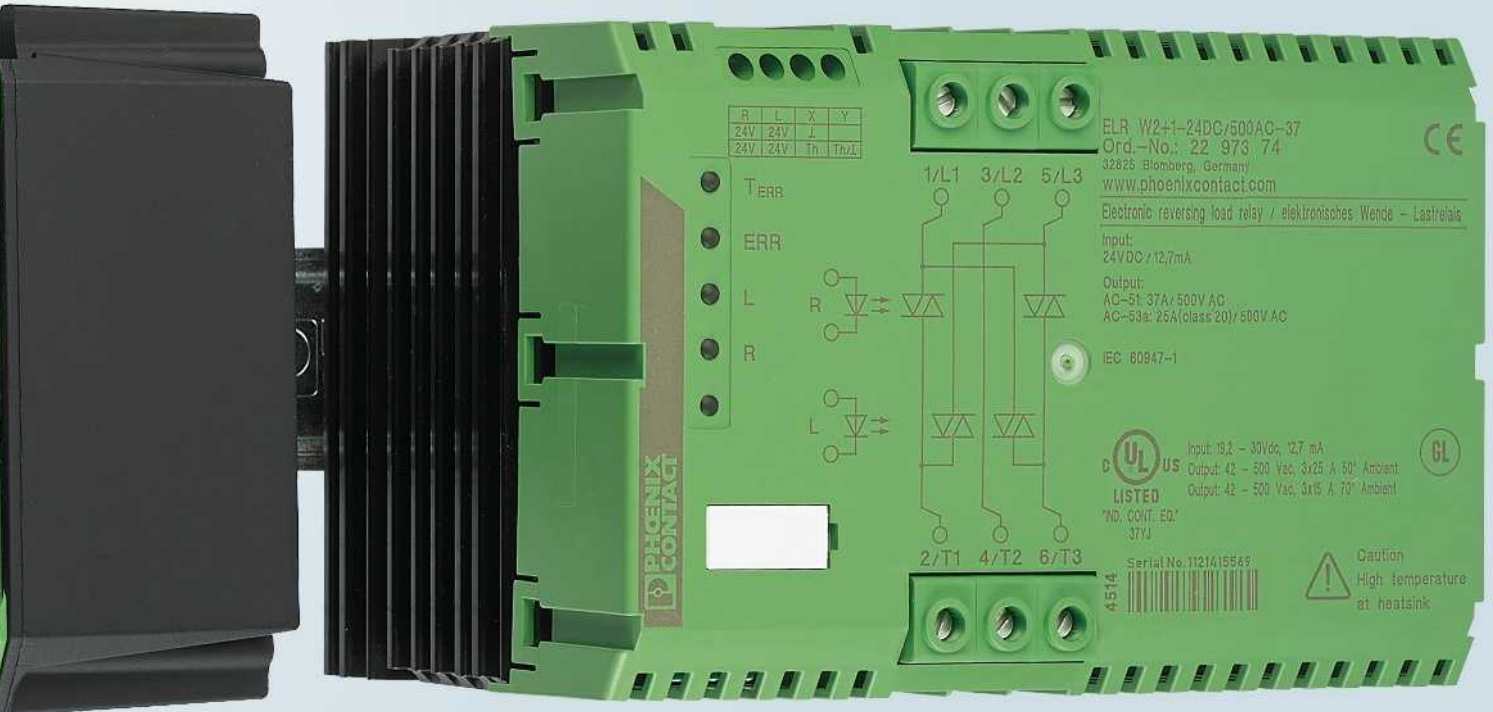





CONTACTRON order overview with accessories

Hybrid motor starters (0.6 A and 2.4 A)





Maximum load current	Input voltage	Functions			
		 Direct starter	 Reversing starter	 Motor protection	 Emergency stop
0.6 A	24 V DC	X	-	X	X
		X	-	X	X
		X	X	X	X
		X	X	X	X
		X	-	X	-
		X	-	X	-
		X	X	X	-
		X	X	X	-
	230 V AC	X	-	X	X
		X	X	X	X
		X	-	X	-
		-	X	X	-
		X	-	X	X
		X	-	X	X
2.4 A	24 V DC	X	-	X	X
		X	-	X	X
		X	X	X	X
		X	X	X	X
		X	-	X	-
		X	-	X	-
		X	X	X	-
		X	X	X	-
	230 V AC	X	-	X	X
		X	X	X	X
		X	-	X	-
		X	X	X	-







Connection technology		Hybrid motor starter		
 Screw	 Push-in	 with networking		 without networking
		IFS connection*	SmartWireDT™*	
X	-	2905154	-	2900566
-	X	2905141	2903936	2903914
X	-	2905151	-	2900582
-	X	2905138	2903933	2903902
X	-	2905162	-	2900542
-	X	2905148	2905076	2903920
X	-	2905157	-	2900573
-	X	2905144	2905073	2903908
X	-	-	-	2900689
X	-	-	-	2900692
X	-	-	-	2900685
X	-	-	-	2900691
X	-	-	-	2900567
-	X	-	-	2903916
X	-	-	-	2900414
-	X	-	-	2903904
X	-	-	-	2900543
-	X	-	-	2903922
X	-	-	-	2900574
-	X	-	-	2903910
X	-	-	-	2900568
X	-	-	-	2900420
X	-	-	-	2900544
X	-	-	-	2900575

* Please select the gateway to match the bus system.

Hybrid motor starters (3 A and 9 A)

Maximum load current	Input voltage	Functions				
		 Direct starter	 Reversing starter	 Motor protection	 Emergency stop	
3 A	24 V DC	X	-	X	X	
		X	-	X	X	
		X	X	X	X	
		X	X	X	X	
		X	-	X	-	
		X	-	X	-	
		X	X	X	-	
		X	X	X	-	
9 A	24 V DC	X	-	X	X	
		X	-	X	X	
		X	X	X	X	
		X	X	X	X	
		X	-	X	-	
		X	-	X	-	
		X	X	X	-	
		X	X	X	-	
		X	-	-	-	
		X	X	-	-	
	X	-	X	X		
	X	-	X	X		
	X	X	X	X		
	X	-	X	-		
	X	-	X	-		
	X	X	X	-		
	230 V AC		X	-	X	X
			X	X	X	X
X			-	X	-	
X			X	X	-	
X			-	-	-	
X			X	-	-	



Connection technology		Hybrid motor starter		
 Screw	 Push-in	 with networking		 without networking
		IFS connection*	SmartWireDT™*	
X	-	2905155	-	-
-	X	2905142	2903937	-
X	-	2905152	-	-
-	X	2905139	2903934	-
X	-	2905163	-	-
-	X	2905149	2905078	-
X	-	2905159	-	-
-	X	2905146	2905074	-
X	-	-	-	2900569
-	X	-	-	2903918
X	-	-	-	2900421
-	X	-	-	2903906
X	-	-	-	2900545
-	X	-	-	2903924
X	-	-	-	2900576
-	X	-	-	2903912
X	-	-	-	2900530
X	-	-	-	2900538
X	-	2905156	-	-
-	X	2905143	2903938	-
X	-	2905153	-	-
-	X	2905140	2903935	-
X	-	2905164	-	-
-	X	2905150	2905079	-
X	-	2905160	-	-
-	X	2905147	2905075	-
X	-	-	-	2900570
X	-	-	-	2900422
X	-	-	-	2900546
X	-	-	-	2900578
X	-	-	-	2900531
X	-	-	-	2900539

* Please select the gateway to match the bus system.

Gateways

Designation	Networking	
	IFS connection	SmartWireDT™
PROFINET gateway	2904472	–
EtherNet/IP™ gateway	2901988	2903244
PROFIBUS gateway	2297620	2903100
CANopen® gateway	2901504	2903098
DeviceNet™ gateway	2901529	–
Modbus/TCP gateway	2901528	2903244

Motor manager

Max. load current	Input voltage	Functions		Networking
		Motor protection	Monitoring	IFS connection*
< 16 A	24 V DC	X	X	2297523
	230 V AC	X	X	2297536
> 16 A	24 V DC	X	X	2297497
	230 V AC	X	X	2297507

Short-circuit-proof hybrid motor starters





Max. load current	Input voltage	For busbar mounting		For DIN rail mounting
		Classic set > 1 cm rail width	Compact set < 1 cm rail width	Set including DIN rail adapter
0.6 A	24 V DC	2904334	2904333	2902952
2.4 A		2904336	2904335	2902953
6.5 A		2904338	2904337	2902954

* Devices can also be operated without a gateway.

Solid-state contactors

Max. load current	Input voltage	Functions		Network		Housing width in mm
		 Direct starter	 Reversing starter	Single-phase	3-phase	
2 A	24 V DC	X	–	–	2297196	40
		X	X	–	2297293	
	230 V AC	X	–	–	2297206	
		X	X	–	2297303	
9 A	24 V DC	X	–	–	2297219	67.5
		X	X	–	2297316	
	230 V AC	X	–	–	2297222	
		X	X	–	2297329	
16 A	24 V DC	X	–	–	2297235	147.5
		X	X	–	2297332	
	230 V AC	X	–	–	2297248	
		X	X	–	2297345	
20 A	24 V DC	X	–	2297138	–	22.5
	230 V AC	X	–	2297141	–	
30 A	24 V DC	X	–	2297154	–	
	230 V AC	X	–	2297167	–	
37 A	24 V DC	X	–	–	2297277	147.5
		X	X	–	2297374	
	230 V AC	X	–	–	2297280	
		X	X	–	2297387	
50 A	24 V DC	X	–	2297170	–	50
	230 V AC	X	–	2297183	–	

Accessories

DIN rail adapter	Busbar adapter for devices with short-circuit protection		DIN rail connector	Data cable	Bridge for all hybrid motor starters (2x)
					
2902747	160 mm	200 mm	2707437	2320500	 Web code: #1080
					To loop through the 3-phase supply 2290449

PHOENIX CONTACT

Products and solutions for your success

As a leading manufacturer of connection technology and automation components, we are always working to transform the growing requirements placed on your application and markets into new innovations. Our products are the nervous system of your industrial system and help you design more efficient processes and reduce costs.

Your advantages:

- Unique product portfolio, thanks to future-oriented innovations and considerable variety.
- High quality, thanks to standardized laboratory tests and high-quality materials
- Professional service through personal consultation:
With 50 subsidiaries and over 30 agencies, we are always close by.
- High delivery reliability, thanks to modern production processes, worldwide production locations, and local warehousing





“Made by Phoenix Contact”

Phoenix Contact relies on in-house competence and expertise in a range of contexts. The design and development departments constantly come up with innovative product ideas, developing special solutions to meet customer requirements. Numerous patents emphasize the company's innovation strength.

Quality down to the smallest detail

It is only when you keep sight of every little detail that you can be sure of the quality. That's why we even produce our own screws. We produce items that later form the basis for high-quality components at our own plastic, metal, and SMD production facilities.

Global approvals and certificates

Our numerous certificates are proof that you can fully trust in our products, because quality is essential. We strive to satisfy this requirement in every respect. For this reason, our systems, processes, and products are inspected and certified several times over.



Always up-to-date, always available to you. Here you'll find everything on our products, solutions and service:

phoenixcontact.com

Product range

- Cables and wires
- Connectors
- Controllers
- Electronics housings
- Electronic switchgear and motor control
- Fieldbus components and systems
- Functional safety
- HMIs and industrial PCs
- I/O systems
- Industrial communication technology
- Industrial Ethernet
- Installation and mounting material
- Lighting and signaling
- Marking and labeling
- Measurement and control technology
- Monitoring
- PCB terminal blocks and PCB connectors
- Power supply units and UPS
- Protective devices
- Relay modules
- Sensor/actuator cabling
- Software
- Surge protection and interference filters
- System cabling for controllers
- Terminal blocks
- Tools
- Wireless data communication

PHOENIX CONTACT GmbH & Co. KG
Flachsmarktstraße 8
32825 Blomberg, Germany
Phone: + 49 5235 3-00
Fax: + 49 5235 3-41200
E-mail: info@phoenixcontact.com
phoenixcontact.com



INSPIRING INNOVATIONS